



M.T.M. Srl | Società Unipersonale  
Via La Morra, 1 | 12062 Cherasco (Cn) | Italy  
Tel. +39 0172 4860140 | Fax +39 0172 593113  
info@brc.it | www.brc.it



<b>Codice istruzione</b> Instruction code Code d'instruction Código instrucción	<b>FSG000063R</b>
<b>Versione</b> Version Version Versión	<b>n° 2 - 1/09/2016</b>
<b>Codice kit</b> Kit code Code kit Código kit	<b>09SQ4SDIP004GH</b>
<b>Sistema</b>	<b>SEQUENT DIRECT INJECTION 2.0</b>
<b>Costruttore</b> Builder Constructeur Constructor	<b>Seat</b>
<b>Modello</b> Model Modèle Modelo	<b>Leon</b>
<b>Cilindrata</b> Cubic capacity Cylindrée Cilindrada	<b>1.4 cc - 16 V - 92 kW</b>
<b>Sigla motore</b> Engine type Type de moteur Código del motor	<b>CZCA</b>
<b>Petrol ECU</b>	<b>BOSCH MED 17.5.25</b>
<b>EURO</b>	<b>6B</b>
<b>Cambio</b> Transmission Transmission Transmisión	<b>Manuale</b> Manual Manuel Manual

Lpg

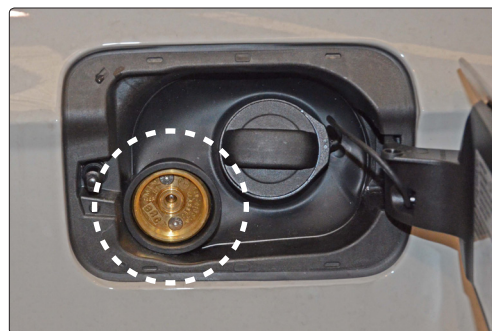
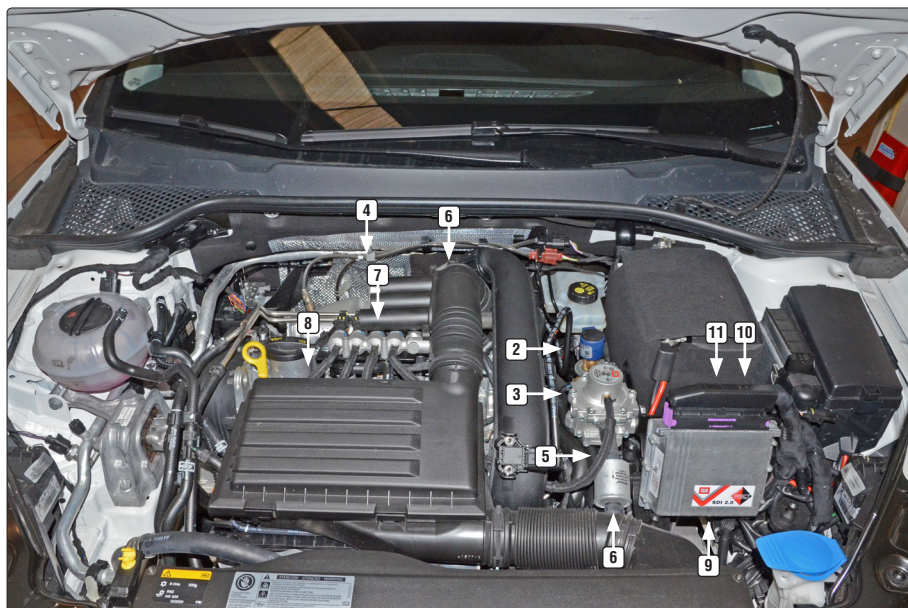

	<b>Descrizione/Description</b> Description/Descripción	<b>Omologazione/Approval</b> Homologation/Homologación
1	 <b>Pres a carica</b> Refuelling point Prise de charge Toma de carga	E13*67R01*0020*
2	 <b>Elettrovalvola ET98 WP</b> ET 98 WP solenoid valve Electrovanne ET 98 WP Electroválvula ET 98 WP	E13*67R01*0015*
3	 <b>Riduttore Genius MB</b> Genius MB Reducer Vapo-detendeur Genius MB Reductor Genius MB	E13*67R01*0016*
4	 <b>Raccordo acqua a "T" (x2)</b> T-shaped water fitting (x2) Raccord eau à "T" (x2) Empalme agua a "T" (x2)	-
5	 <b>Depressione riduttore</b> Vacuum reducer Dépression vapo-detendeur Depresión reductor	-
6	 <b>Filtro Certools</b> Filter Certools Filtre Certools Filtro Certools	E13*67R01*0168*
7	 <b>Rail con 4 iniettori Normal BRC MY09</b> Rail with 4 BRC MY09 Normal injectors Rail avec 4 injecteurs Normal BRC MY09 Rail con 4 inyectoros Normal BRC MY09	E13*67R01*0185* (Rail) E13*67R01*0262* (Sensor) E13*67R01*0223* (Injectors)
8	 <b>Ugelli gas</b> Gas nozzles Buses gaz Boquillas de gas	-
9	 <b>Centralina Gas</b> Gas ECU Centrale Gaz Centralita Gas	E3*67R01*1002*
10	 <b>Portafusibili</b> Fuse holder Porte-fusible Portafusibles	-
11	 <b>Pres a diagnosi (Gas)</b> (Gas) Diagnostic connector Connecteur diagnostic (Gaz) Conector de diagnóstico (Gas)	-
12	 <b>Commutatore</b> Changeover switch Commutateur Conmutador	-

## ISTRUZIONI GENERALI

Per una corretta installazione dell'impianto seguire le seguenti raccomandazioni:

- Controlla la versione e la data di questa istruzione sul nostro sito web WWW.BRC.IT ("Area Riservata")! È responsabilità dell'installatore controllare le regolamentazioni nazionali affinché siano fatti eventuali adeguamenti al montaggio. • Prima di iniziare l'installazione del sistema, smontare la batteria. • Staccare la centralina benzina originale. • Consultare il manuale di manutenzione dell'autovettura durante le operazioni di smontaggio e rimontaggio delle parti originali. • Tutte le misure e dimensioni sono espresse in millimetri, se non diversamente specificato. • Tutti i componenti Gas devono essere installati sul telaio/scocca della vettura. • Verificare che tutti i componenti, compresi i tubi, siano correttamente fissati, che non siano a contatto o troppo in prossimità di parti in movimento durante la marcia. • Verificare che i tubi non siano fissati a componenti che possano trasmettere rumori (parti in plastica, tubi freni,...) evitare quindi che eventuali "C" di plastica siano a contatto con componenti meccanici, in questo modo si eviteranno vibrazioni e rumorosità in marcia. • Verificare che i tubi non abbiano raggi di curvatura troppo stretti o che siano strozzati. • Prestare particolare attenzione che i componenti meccanici non abbiano vibrazioni e che non creino rumorosità in marcia. • Si raccomanda di segnare i raccordi già chiusi con un pennarello.
- Evitare qualsiasi tipo di sfregamento dei componenti gas con parti del motore • Non installare la centralina Gas a contatto della batteria. • Durante le forature prestare attenzione ai componenti sottostanti. Rimuovere tutte le bave risultanti dalle forature e trattare i fori con antiruggine. • Per rimuovere un raccordo, usare due chiavi. • Rispettare le indicazioni sulle coppie di serraggio. • Usare sempre le corrette fascette durante la connessione delle tubazioni.
- Non lasciare residui di gomma durante il taglio delle tubazioni. Soffiarle con aria compressa. • Rivestire le tubazioni gas con della guaina anti-abrasione. • Controllare le misure i colori e le posizioni dei cavi.
- Quando presenti utilizzare i connettori elettrici del cablaggio. • Tutte le connessioni non precablate devono essere effettuate tramite brasatura dolce (saldatura a stagno) ed essere adeguatamente isolate. Badare che le saldature non siano "fredde" e non rischino di staccarsi col tempo. Eventuali fili del cablaggio non utilizzati devono essere accorciati ed isolati separatamente. Non usare saldatori che si collegano alla batteria della stessa auto, oppure saldatori di tipo rapido. • Prevenire il rischio di danno al cablaggio ed alle tubazioni. • Curare la pulizia durante le operazioni di montaggio di tutte le parti gas. • I componenti vanno sostituiti con altri di uguali caratteristiche.
- Rispettare le regolamentazioni (R67-01-R110).

**⚠** • NEL CASO DI VERNICATURA "A FORNO", IL SERBATOIO DEVE ESSERE RIMOSSO DAL VEICOLO.

**ATTENZIONE: IL COLLEGAMENTO DI QUALSIASI DISPOSITIVO DI DIAGNOSI AL CONNETTORE OBD, PUÒ CAUSARE GRAVI MALFUNZIONAMENTI AL SISTEMA BRC SDI 2.0. IN CASO SI RENDA NECESSARIO CONNETTERE UN DIAGNOSTICO OBD, È RICHIESTO DI UTILIZZARE IL VEICOLO IN MODALITÀ "FORZATO BENZINA".**

## GENERAL INSTRUCTIONS

When installing the gas system, compliance is required with the following guidelines:

- Check on website WWW.BRC.IT ("Reserved Area") version and date of this instruction! It's the installer's responsibility to check the national regulations to make all necessary assembly adaptations. • Before starting system installation, remove battery. • Disconnect original petrol ECU. • Consult the vehicle maintenance manual while assembling and disassembling original components. • All measures and dimensions are given in mm, unless indicated otherwise. • All Gas components must be installed on vehicle chassis/bodywork. • Check that all components, pipes included, are correctly fixed, in contact or in close proximity to moving parts during running. • Check pipes are not fixed to components that could produce noise (plastic components, brake pipes,...); keep "C" plastic fittings away from mechanical components in order to avoid vibrations and noise during running. • Check pipes are not narrowed or too bent. • Pay special attention to the contact with mechanical components in order to avoid vibrations and noise during running.
- Mark fittings with a pen once they are closed is recommended. • Avoid any friction amongst gas components and engine parts • Do not install Gas ECU against the battery. • When drilling be careful for the underlying parts. Deburr holes in the plating and treat them for rust. • Use two spanners to remove a fitting. • Respect torque wrenches. • Use the right pipe clamps when connecting pipes. • Remove any rubber waste due to pipes cut. Blow it away with compressed air. • Cover gas pipes with anti-abrasion sheath. • Check measurements given and wire colours and positions. • Use harness electrical connectors, when available. • All not pre-cabled connections must be realized through soft soldering and suitably insulated. Check soldering is not "cold" and well fixed. In case of not used cables, shorten and insulate them separately. Do not use soldering irons directly connected to the vehicle battery or quick soldering irons. • Prevent the risk of damage from wiring harnesses and pipes. • Keep the area clean while installing gas components. • Components must be replaced with other equivalent parts. • Observe regulations (R67-01-R110).

**⚠** • IN CASE OF OVEN PAINTING, TANK MUST BE FIRST REMOVED FROM THE VEHICLE.

**WARNING: THE CONNECTION OF ANY DIAGNOSTIC DEVICE TO THE OBD CONNECTOR CAN CAUSE SERIOUS FAILURES TO THE BRC SDI 2.0 SYSTEM. IF AN OBD DIAGNOSTIC DEVICE SHOULD BE CONNECTED, THE VEHICLE MUST BE IN "FORCED PETROL" MODE.**

## INSTRUCTIONS GENERALES

Veuillez respecter les instructions suivantes pendant l'installation du système gaz:

- Merci de vérifier sur notre site internet WWW.BRC.IT ("Espace Réservé") la version et la date de cet instruction! • C'est la responsabilité du mécanicien de vérifier et respecter les normes nationales pour réaliser toutes modifications nécessaires pour le montage. • Avant le montage de l'installation gaz, déconnectez la batterie. • Déconnectez le calculateur essence d'origine. • Consultez le manuel d'entretien du véhicule pendant le démontage et montage des pièces originales. • Sauf autrement indiqué, toutes les mesures sont exprimées en mm. • Tous les composants Gaz doivent être installés sur le châssis/coque du véhicule. • Vérifiez que tous les composants, tuyaux compris, sont fixés correctement, ne touchent pas ou ne sont pas trop près de parties mobiles pendant la marche. • Vérifiez que les tuyaux ne sont pas fixés à composants que peuvent transmettre du bruit (parties en plastique, tuyaux des freins) ; empêchez que des raccords à "C" en plastique touchent des composants mécaniques pour éviter vibrations ou bruit pendant la marche. • Vérifiez que les tuyaux ne sont pas ébranchés ou trop courbés. • Assurez-vous de bien empêcher le contact entre des composants mécaniques pour éviter vibrations ou bruit pendant la marche. • On recommande de marquer au feutre les raccords déjà fermés. • Evitez les frottements entre les composants gaz et le moteur. • Ne pas installer le calculateur Gaz au contact de la batterie. • Faites attention aux pièces adjacentes pendant les perçages. Les trous réalisés dans la tôle doivent être ébavurés et protégés contre la rouille. • Utilisez toujours deux clés pour enlever un raccord. • Respectez les couples de serrage. • Serrez toujours les tuyaux avec les colliers corrects. • Ne pas laisser résidu en gomme en coupant les tuyaux. Soufflez à l'air comprimé. • Recouvrez les tuyaux gaz et eau avec de la gaine anti-abrasion. • Contrôlez à l'avance les mesures, les couleurs des fils et les positions indiqués. • Utilisez les connecteurs électriques du câblage si disponibles. • Les connexions non pré-câblées doivent être réalisées avec soudure à l'étain et être isolées de façon adéquate. Vérifiez que la soudure n'est pas « froide » et bien fixée. Les câbles non utilisés doivent être raccourcis et isolés séparément. Ne pas utiliser des fers à souder qui se branchent à la batterie de la même voiture, ou des fers de type rapide. • Prévenez le risque de dommages au câblage et aux tuyaux. • Gardez l'aire propre pendant le montage des composants gaz. • Les composants doivent être remplacés avec d'autres équivalents. • Respectez la réglementation (R67-01-R110).

**⚠** • DANS LE CAS DE PEINTURE AU FOUR, LE RÉSERVOIR DOIT ÊTRE PRÉVENTIVEMENT ENLEVÉ DU VÉHICULE.

**ATTENTION: LA CONNEXION D'UN DISPOSITIF DE DIAGNOSTIC AU CONNEXEUR OBD PEUT CAUSER DES GRAVES DÉFAILLANCES AU SYSTÈME BRC SDI 2.0. SI LA CONNEXION D'UN DISPOSITIF DE DIAGNOSTIC OBD EST NÉCESSAIRE, LE VÉHICULE DEVRA ÊTRE UTILISÉ EN MODALITÉ "FORCÉE ESSENCE".**

## INSTRUCCIONES GENERALES

Cumplir con las instrucciones siguientes instalando el sistema de gas:

- Revise en nuestra página web WWW.BRC.IT ("rea Reservada") la fecha y versión de esta instrucción! • El instalador tiene la responsabilidad de cumplir con las regulaciones nacionales y realizar las adaptaciones necesarias para el ensamblaje. • Antes de instalar el sistema, desmonte la batería. • Desconecte la centralita gasolina originaria. • consulte el manual del vehículo durante el desmontaje y remontaje de los componentes originarios. • Todas las medidas son en mm, salvo indicación en contrario. • Todos los componentes Gas deben instalarse sobre el chasis/bastidor del vehículo. • Verifique que todos los componentes, tubos incluidos, están correctamente fijados, no están en contacto o demasiado cerca de partes móviles durante la marcha. • Verifique que los tubos no están fijados a componentes que transmitan ruido (componentes en plástico, tubos frenos,...); evitar el contacto entre empalmes de "C" en plástico y componentes mecánicos para que no se produzcan vibraciones y ruidos en marcha. • Verifique la ausencia de estrangulamientos o curvas muy estrechas en los tubos. • Verifique que los tubos están correctamente fijados entre Brida LDI/ Brida gasolina y FSU, y entre FSU y bomba de Alta Presión (Marcar las orillas de los tubos con cintas adhesivas pintadas antes de conectarlos para evitar posibles sustitución - Véase pág. 11 para la correcta indicación de los colores durante la instalación). • Prestar atención al contacto entre componentes mecánicos evitando vibraciones y ruidos durante la marcha. • Se aconseja marcar los empalmes ya cerrados con un rotulador. • Evite el rozamiento entre los componentes gas y partes del motor • No instale la centralita Gaz en contacto con la batería. • Cuando taladre, tenga cuidado especial en las partes inferiores. Lime los agujeros y trátelos contra corrosión. • Siempre utilice dos llaves para quitar un empalme. • Respete todos los pares de torsión. • Utilice los anillos de manguera correctos cuando conecte los tubos. • No deje residuos de goma cortando los tubos. Sople con aire comprimido. • Revista los tubos gas y agua con vaina anti-abrasión. • Verifique las medidas, los colores del cableado y sus posiciones. • Utilice los conectores eléctricos del cableado si presentes. • Las conexiones no precableadas deben realizarse a través de estaño y ser perfectamente aisladas. Prestar atención en que las soldaduras no sean "frías" y no corran el riesgo de despegarse. Todos cables inutilizados deben cortarse y aislarse separadamente. No utilizar soldadores que se conectan a la batería del mismo vehículo ni soldadores de tipo rápido. • Prevenga el riesgo de daño del cableado y tubos. • Mantenga el área limpia durante el montaje de los componentes gas. • Los componentes deben reemplazarse con otros equivalentes. • Respete las regulaciones (R67-01-R110).

**⚠** • EN CASO DE PINTURA AL HORNO, PRIMERO quite el tanque del vehículo.

**CUIDADO: LA CONEXIÓN DE DISPOSITIVOS DE DIAGNÓSTICO AL CONECTOR OBD PUEDE CAUSAR SERIOS PROBLEMAS AL SISTEMA BRC SDI 2.0. SI LA CONEXIÓN DE DIAGNÓSTICO OBD ES NECESARIA, EL VEHÍCULO TENDRÁ QUE SER UTILIZADO EN MODALIDAD "FORZADA GASOLINA".**

## LEGENDA SIMBOLI / SYMBOLS LEGEND / LEGENDE DES SYMBOLES

### LEYENDA SÍMBOLOS / ZEICHENERKLÄRUNG



**Montare**  
Assemble  
Monter  
Montar



**Segnare**  
Mark  
Marquer  
Marcar



**Bullone**  
Bolt  
Boulonner  
Atornille



**Dado**  
Nut  
Écrou  
Tuerca



**Filetto**  
Thread  
Filet  
Rosca



**Batteria+**  
Battery+  
Batterie+  
Bateria+



**Percorso cablaggio**  
Wiring harness route  
Route câblage  
Recorrido cableado



**Percorso cablaggio**  
Wiring harness route  
Route câblage  
Recorrido cableado



**Smontare**  
Disassemble  
Démonter  
Desmontar



**Percorso tubazione**  
Hose route  
Route tuyau  
Recorrido tubo



**Forare**  
Drill  
Percer  
Perforar

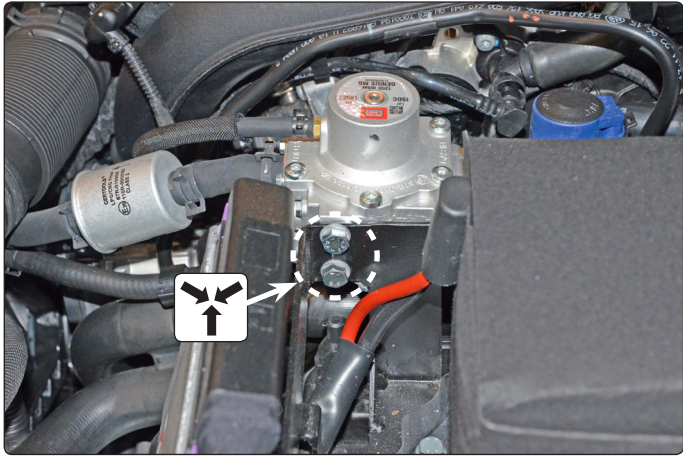





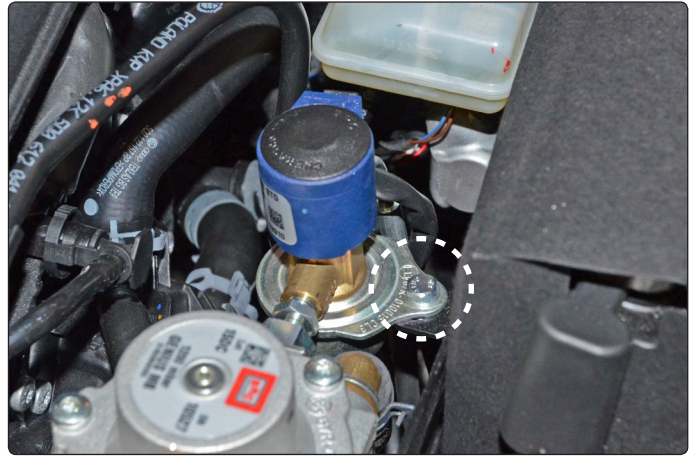

**2X M8X14**  
**CH13**





**M6X16**  
**CH10**





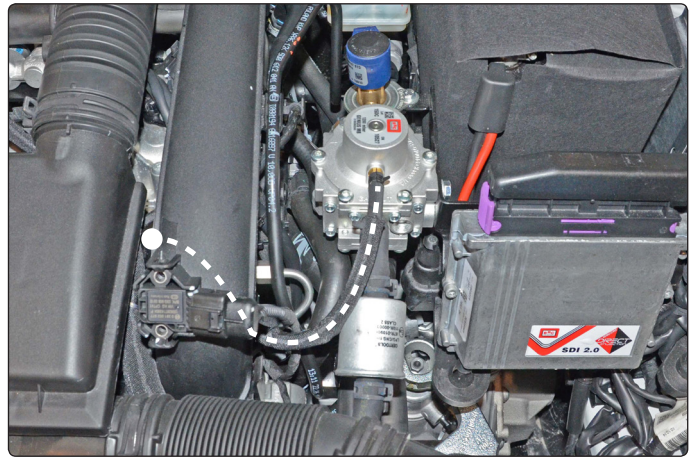

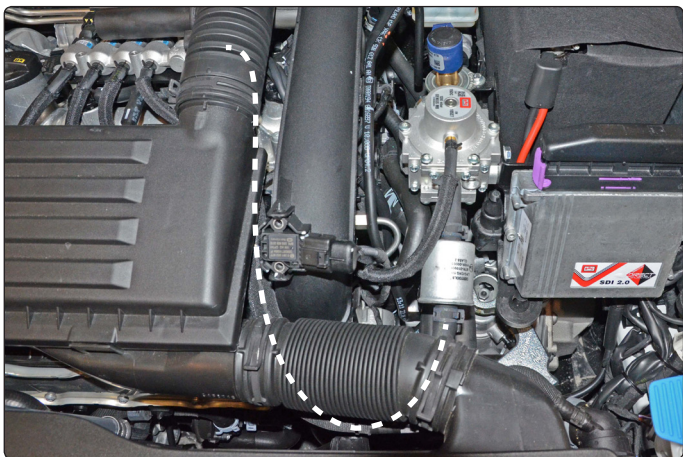

**x2**





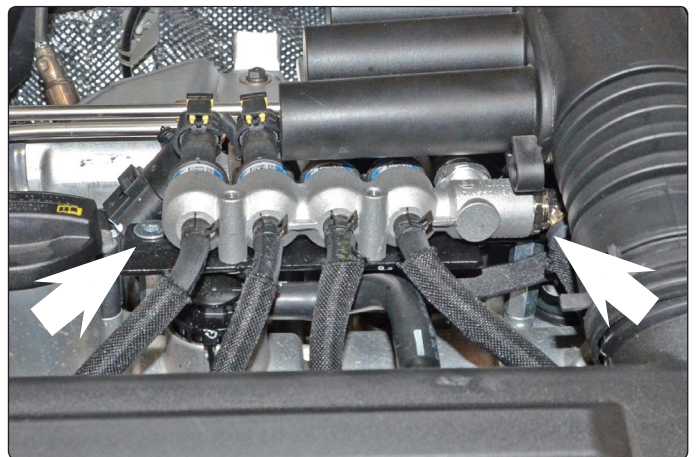









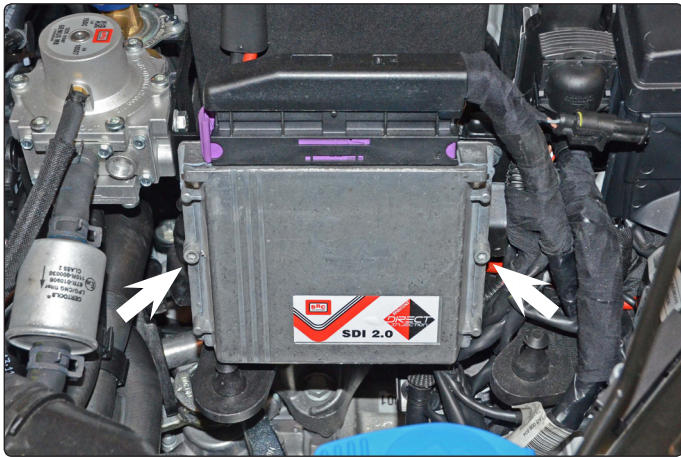
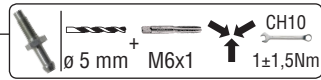
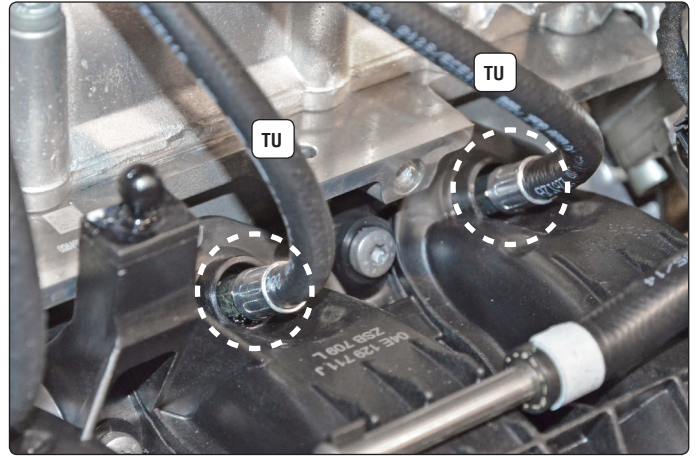
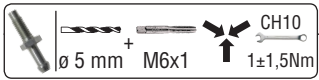
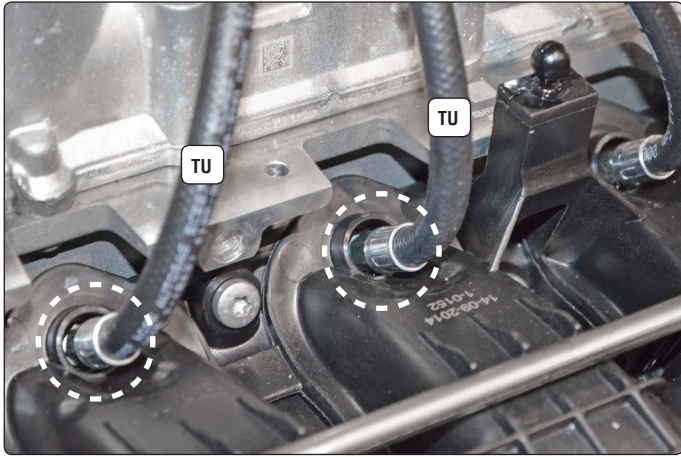

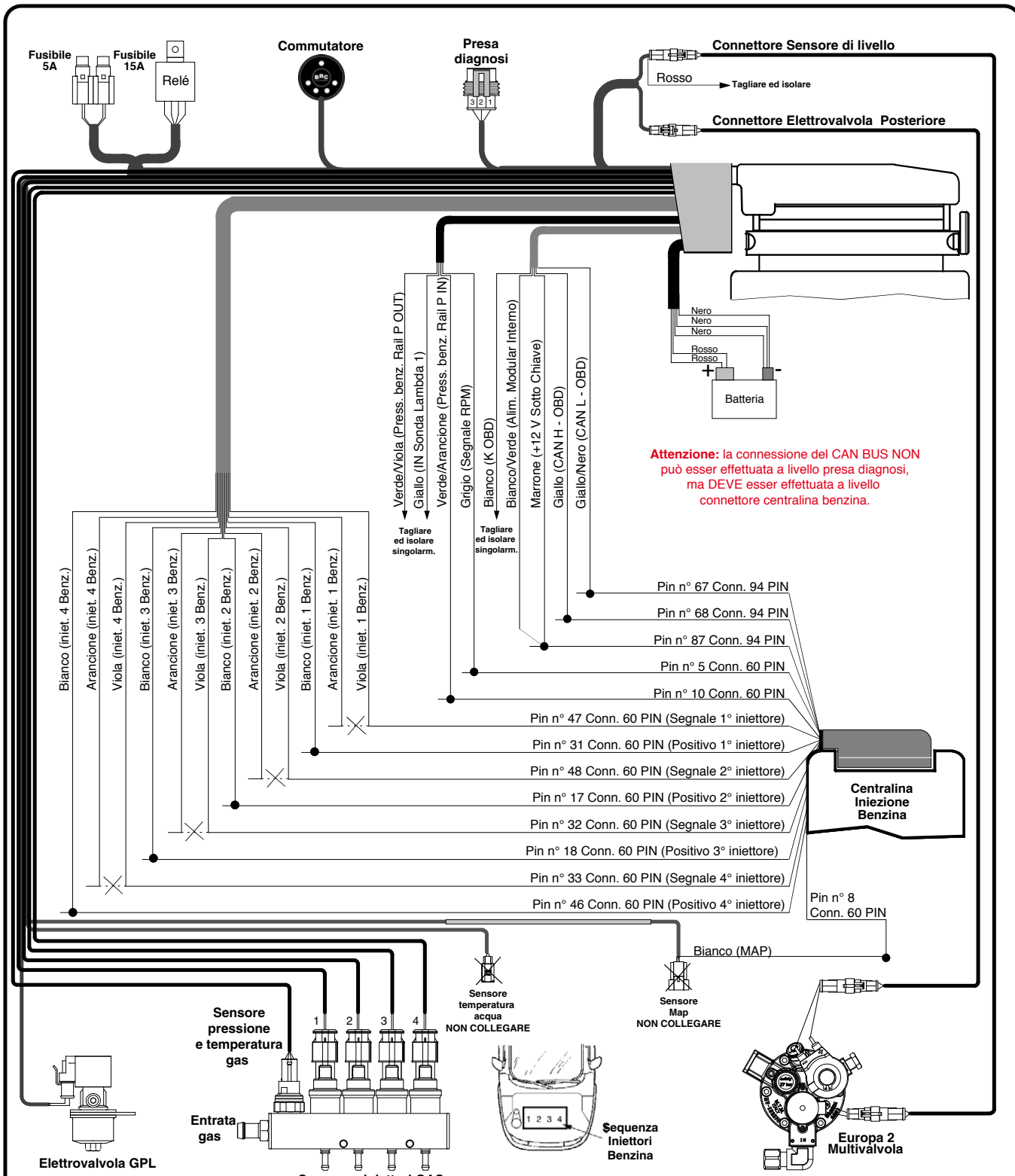

**Schema collegamento parte elettrica  
SEQUENT DIRECT INJECTION 2.0  
Leon 1.4 16V 92kW CZCA EURO 6B GPL  
Iniezione Elettronica Multipoint**

Data:	21_03_16
Rev. N°:	0
An. Rev. del:	///
Disegn.:	I.C.
Visto:	



**ATTENZIONE:**

- Seguire scrupolosamente la sequenza iniettori benzina ed iniettori gas come indicato nello schema.
- Non collegare mai a massa i fili dell'Elettrovalvola anteriore e posteriore.
- Per consentire una corretta diagnosi dell'Elettrovalvola anteriore e di quella posteriore non collegarle tra di loro.
- Non sostituire mai i fusibili con altri di portata superiore.

**AVVERTENZE:**

Attenzione alle auto per le quali la casa costruttrice sconsiglia o vieta di scollegare la batteria, per non alterare antifurti o autoadattività - Non usare mai saldatori collegati alla batteria della stessa auto - Eseguire i collegamenti con saldature a stagno opportunamente isolate - Posizionare i dispositivi elettrici BRC in zona ben ventilata, al riparo da infiltrazioni d'acqua e da fonti di calore - Si raccomanda di isolare i fili della centralina BRC che non vengono collegati - BRC si riserva di modificare il presente schema senza alcun preavviso - Si consiglia di verificare di essere in possesso dell'ultima revisione di schema redatta dalla BRC.



**Wiring Diagram**  
**SEQUENT DIRECT INJECTION 2.0**  
**Leon 1.4 16V 92kW CZCA EURO 6B GPL**  
**Multipoint Electronic Injection**

Date:	21_03_16
Diagram n°:	0
In place of diagram n°	///././
Draftsman.:	I.C.
Signature:	

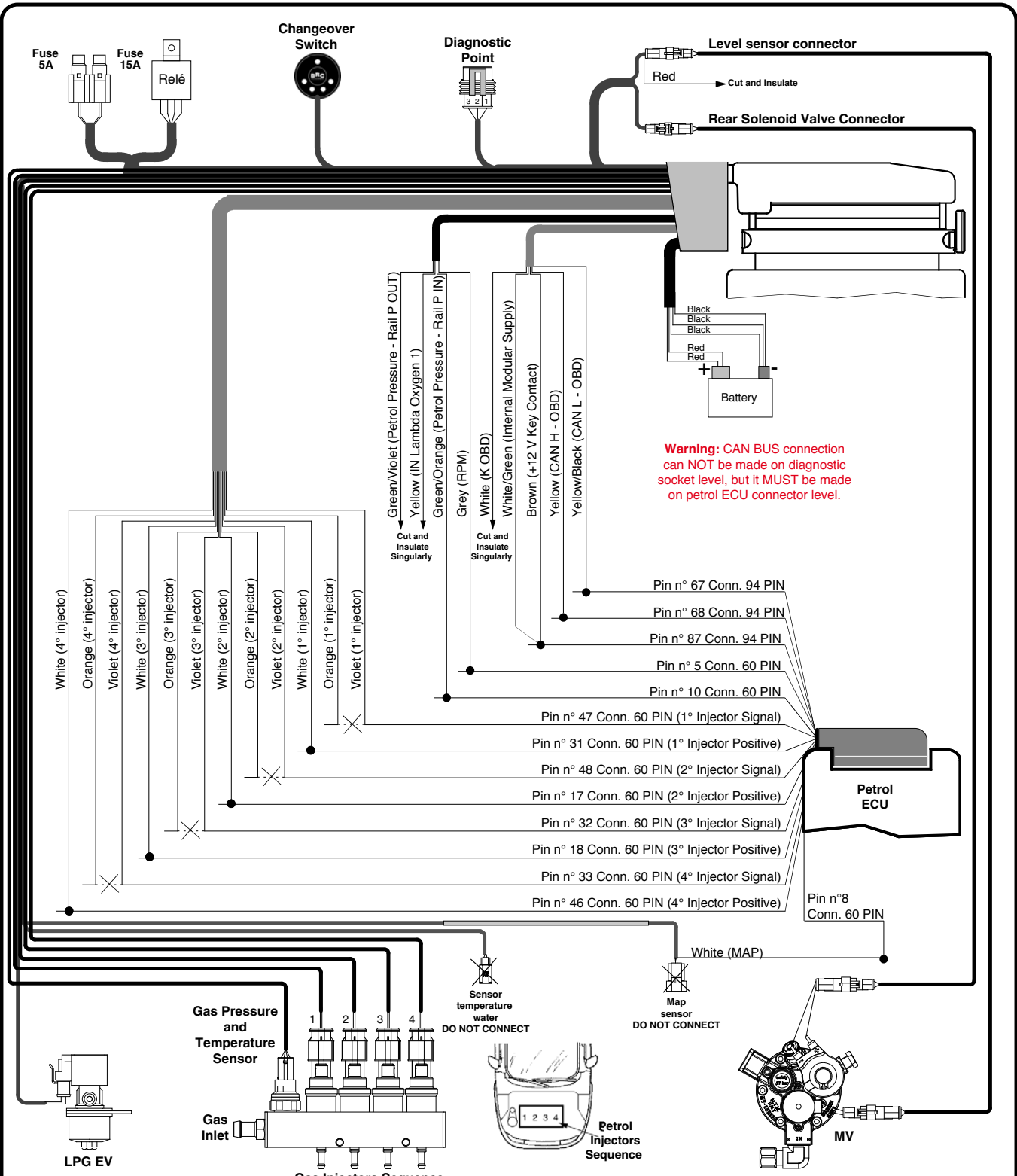

**Warning:** CAN BUS connection can NOT be made on diagnostic socket level, but it MUST be made on petrol ECU connector level.

- WARNING:**
- Follow carefully petrol and gas injectors sequence as shown in the diagram.
  - Never connect front and back Solenoid Valve cables to the Ground.
  - In order to make a front and back Solenoid Valve right diagnostic, don't connect them to each other.
  - Never replace fuses with another ones with bigger amperage.

**CAUTION:**  
 Be careful with the cars for which the manufacturer prohibits or advises against disconnecting the battery, not to alter the antitheft devices or automatic adaptivity - Never use welders connected to the battery of the same car - Connect with suitably insulated soft solderings - Position the BRC electrical devices in a well ventilated area, protected from water seepages and heat sources - We recommend to insulate the BRC electronic control unit wires which are not connected - BRC reserves the right to modify this diagram without notice - We also recommend you to be sure to have the last revision of the diagram drawn up by BRC.